

Drawing Circles

Name: _____ Class: _____

Use the grids to draw circles given the diameters. Use your compass and start in the center of the grids

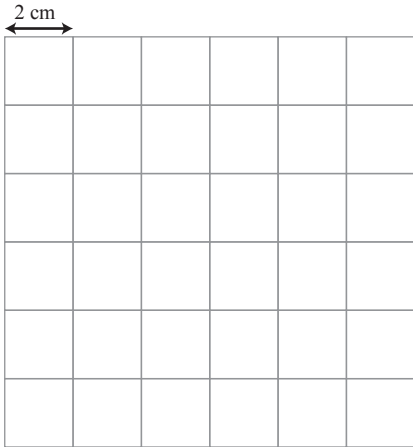

Diameter: 12 cm

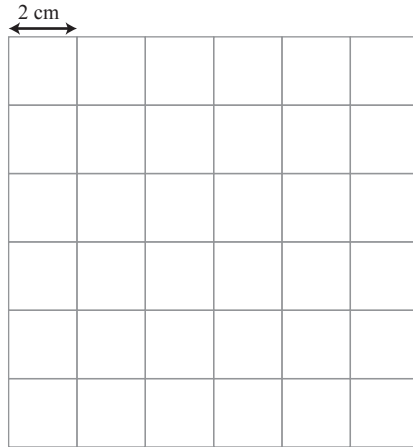

Diameter: 4 cm

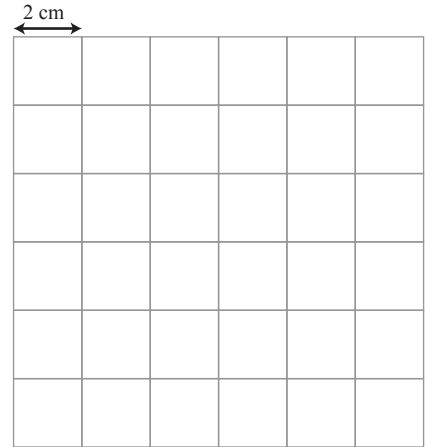

Diameter: 8 cm

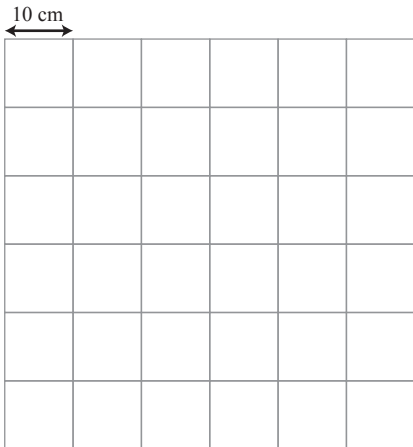

Diameter: 60 cm

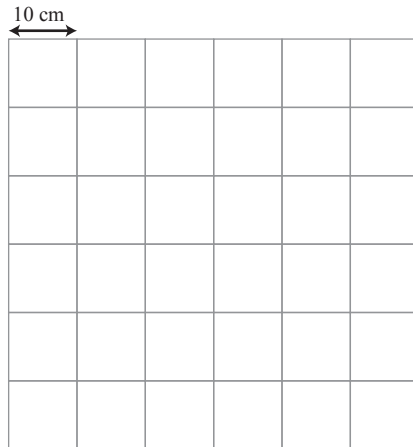

Diameter: 40 cm

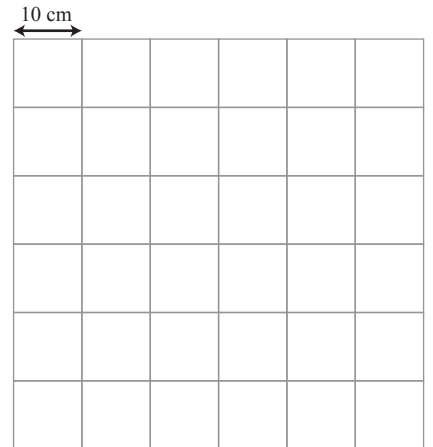

Diameter: 20 cm

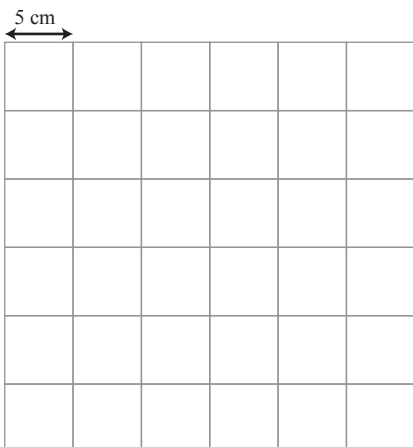

Diameter: 30 cm

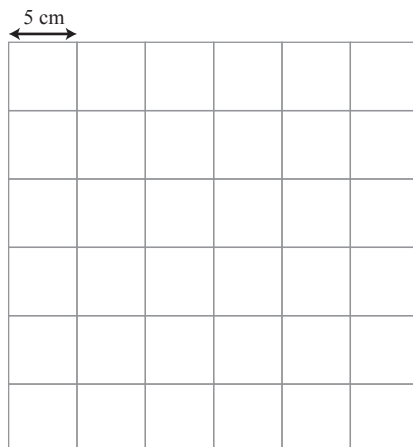

Diameter: 20 cm

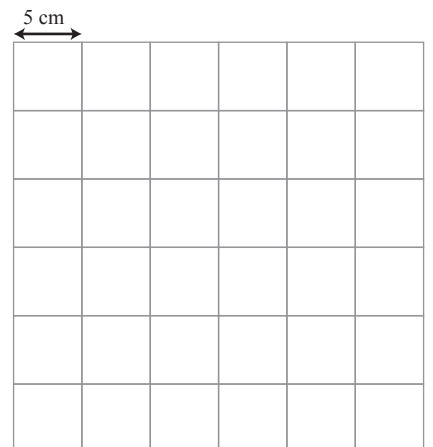

Diameter: 30 cm

Answers

Use the grids to draw circles given the diameters. Use your compass and start in the center of the grids

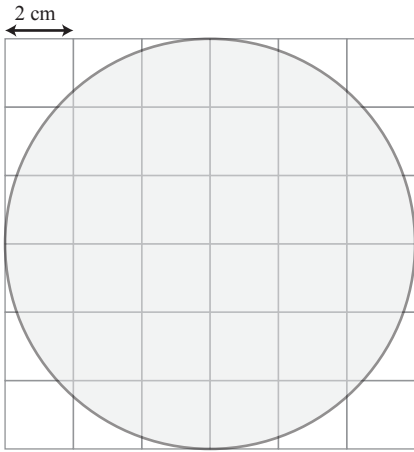

Diameter: 12 cm

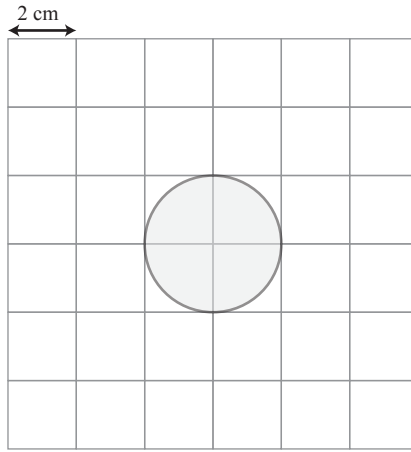

Diameter: 4 cm

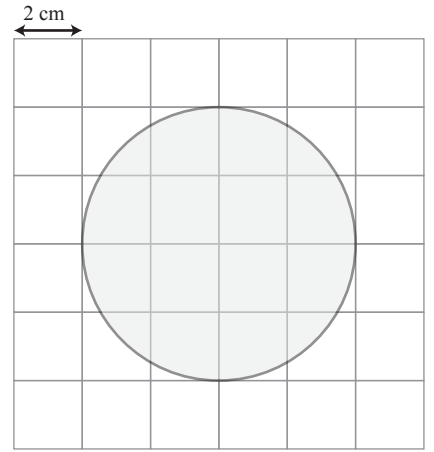

Diameter: 8 cm

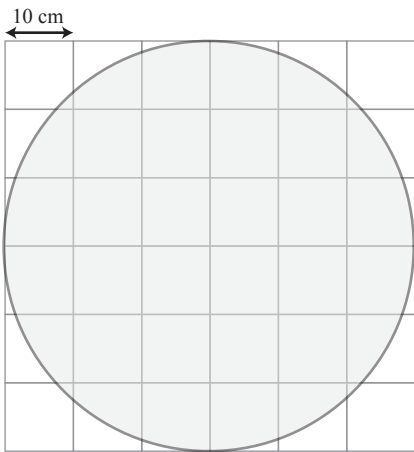

Diameter: 60 cm

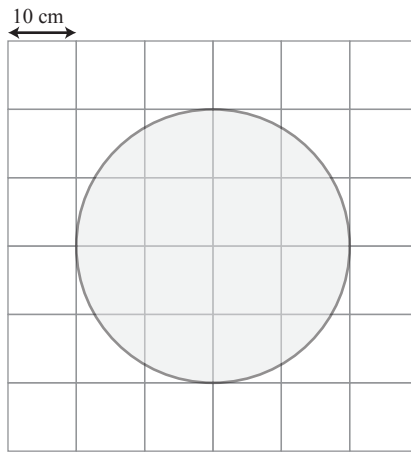

Diameter: 40 cm

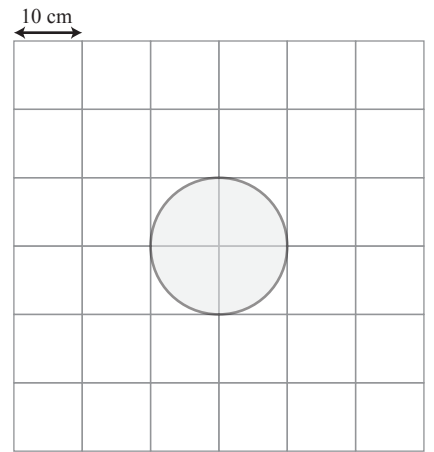

Diameter: 20 cm

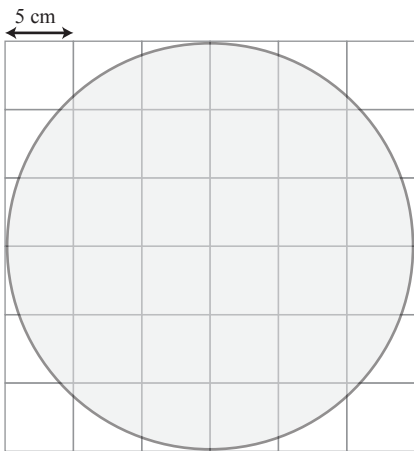

Diameter: 30 cm

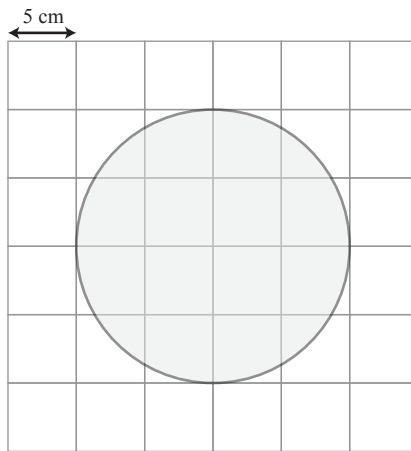

Diameter: 20 cm

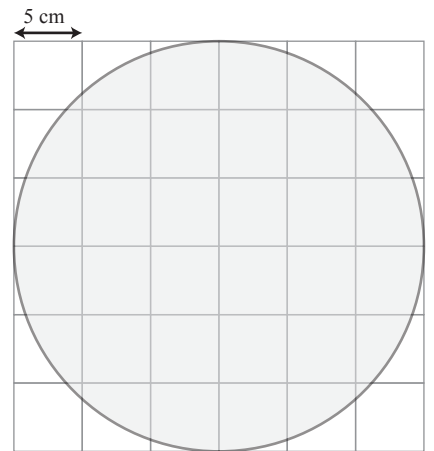

Diameter: 30 cm